

# OWNER'S MANUAL



**ACTIVE MONITOR AV-2(C)**



FUNDAMENTAL ACOUSTIC RESEARCH

Thank you for choosing the FAR AV-2(C) active two way monitor.

In order to obtain the best performance from this active monitor, please be sure to read this owner's manual and use your speaker only in accordance with its instruction.

### CONTENTS

• Applications	2
• Installation	3
• Technical description	4
• Technical drawing	7;8
• Fine frequency tuning	9
• Limiter function	10
• Rear panel level	10
• Troubleshooting	11
• Optional curves	13
• Optional remote control	14

## AV-2(C)

### Applications

Video and film post production

Music industry

All near field and close field applications

Thank you for choosing a FAR active monitor. This unit is an exceptional product that will give you years of superb performance.

### Do Not Open The Cabinet.

Do not attempt to service this unit. Tampering with internal components can cause fire or shock, and may void your guarantee. If water or small objects enter the unit, unplug the power cord immediately and consult an authorized FAR dealer. Using the unit under such condition may cause a fire or shock hazard.

### Installation

#### Mains

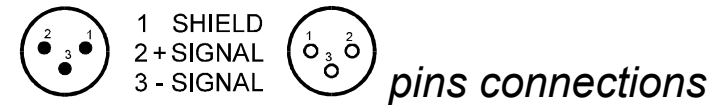
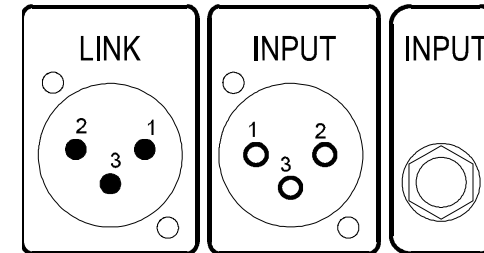
Attach the plug to the IEC socket. And connect it to the mains.

A green LED on front face indicates when the power is switched on.

#### Signal

The input signal is available in XRL or Jack plugs, both are electronically symmetric inputs.

The link functions the same as both of the inputs. Use the link to connect one speaker to another.



- Maximum length of the link cables
  - symmetric : 15 meters
  - asymmetric : 8 meters
- Maximum linked AV-2(C) 's : 4

## TECHNICAL DESCRIPTION

### **AV-2(C)**

<b>Sensitivity</b>	<b>dB SPL</b>	
--------------------	---------------	--

Maximum pressure level (2 cabinets @ 1 m)

117

<b>Frequency Range</b>	<b>Hz</b>	
------------------------	-----------	--

± 3 dB

50-22000

Low pass section

Crossover frequency

3500 Hz 24 dB/Octave

Control

-1dB/flat/+1dB/+2dB

High pass section

Crossover frequency

7500 Hz 24 dB/Octave

Control

-3dB/-2dB/-1dB/flat/+1dB/+2dB

Bandpass filter

20-20000 Hz 6 dB/Octave

Limiter

(on/off) +2dB

<b>Components</b>		
-------------------	--	--

Woofer

17 cm / 6,5 inch

Tweeter soft dome

1 inch



<b>Listening position</b>	<b>cm</b>	
		50-120

**Amplifier Specifications**

<b>Power (PEAK)</b>	<b>W</b>	
---------------------	----------	--

Tweeter: Power 100

Woofer: Power 150

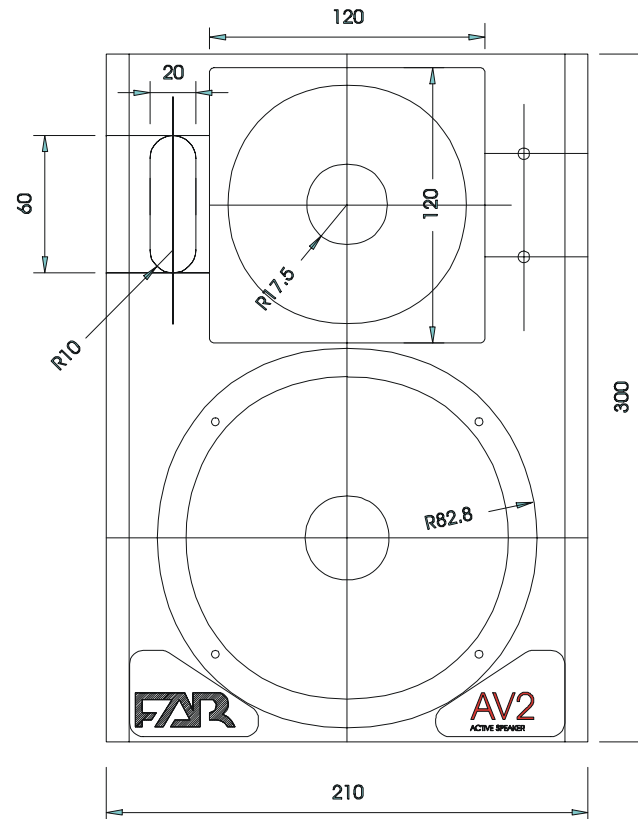
<b>Power (NOMINAL)</b>	<b>W</b>	
------------------------	----------	--

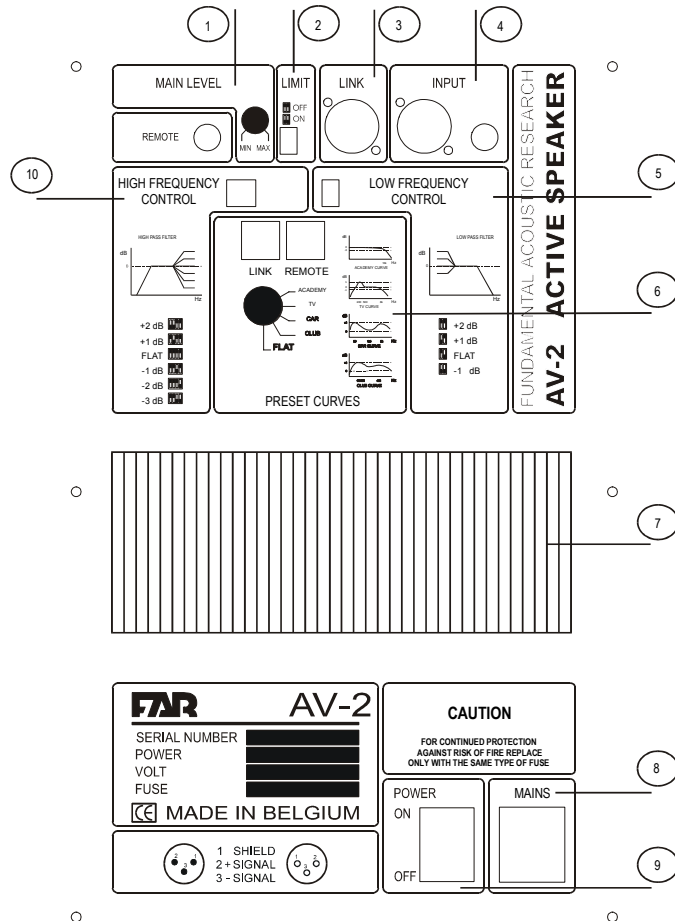
Tweeter: Power @ 8 Ohm 70

Woofer: Power @ 4 Ohm 100

<b>Characteristics</b>		
Power bandwidth		20 - 25000 Hz
Slew rate		35 V/ $\mu$ s
SN ratio		> 100 dB
<b>Distortion</b>		
Intermodulation		0,01%
Total		0,05%
<b>Input</b>		
Sensitivity		0 dB
Impedance		> 10 kOhm
<b>Connectors</b>		
Input (symmetric)		XLR & Jack
Link		XLR
Remote		RJ-45
<b>External dimensions</b>		
	<b>mm</b>	
Height		300
Width		210
Depth		320
<b>Weight</b>		
	<b>kg</b>	<b>12</b>

**TECHNICAL DRAWING**





## LEGEND

1. Main level tuning
2. Limitor function
3. Link
4. Input XLR
5. Low pass section settings
6. Pre-set curves
7. Cooling system
8. Mains
9. Power
10. High pass section settings



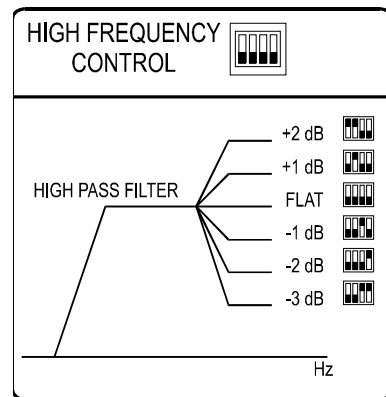
**Fine frequency tuning**

For fine frequency tuning use the dip switches on the rear panel. One for high frequencies (Figure 1) and one for the low frequencies (Figure 2).

**High pass section settings**

The dip switch can be set to one of the six dB level positions for an optimum high frequencies setting

Positions available: -3, -2, -1, flat, +1, +2 dB

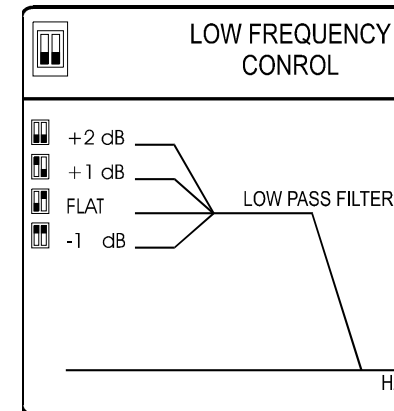


*Figure 1 : high frequency control*

**Low pass section settings**

The dip switch can be set to one of the four dB level positions for an optimum low frequencies setting

Positions available: -1, flat, +1, +2 dB



*Figure 2: Low frequency control*

## Limiter function

The AV-2(C) has a built in limiter developed to protect the drivers against harmful signals. The limiter acts directly on the input signal by decreasing it when it reaches the clipping level.

To activate the limiter turn it to the on or off position using the dip switch on the rear panel.

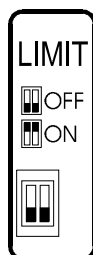


Figure 3: limiter switch

The overload LED indicates whether or not the limiter is in operation.

LED comes :

- Red when the limiter is not in use.
- Orange when the limiter is in use.

## Rear panel level.

Adjust the sound level by turning the main level knob to the desired position.

The range of tuning is from 0 (maximum attenuation) to max (no attenuation).

Adjust the knob (Figure4) to the necessary to attain a perfect stereo image.

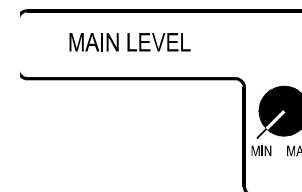


Figure 4 : main level control



## **TROUBLESHOOTING**

This section is designed to trouble free technical operation. Most of the problems encountered by the users are due to operating mistakes .Please check this list first for a possible solution. If the problem persists, consult your local FAR distributor or EMAIL to : [support@far-audio.com](mailto:support@far-audio.com)

### **Your problem is**

### **Make sure that**

No light comes on when the power cord is plugged into AC outlet.	<ul style="list-style-type: none"> <li>• The unit is plugged into a live outlet</li> </ul>
No sound is heard	<ul style="list-style-type: none"> <li>• That the level control at the rear is not turned to the minimum</li> <li>• That the remote control is plugged in the right way</li> <li>• That your audio connection is properly done</li> <li>• That the remote control is not on mute position or –80 dB position.</li> </ul>
Sound is heard stronger from one side.	<ul style="list-style-type: none"> <li>• That the remote control is not on one side only</li> <li>• That both level controls on the rear are correctly turned on the same position.</li> </ul>
When listening to stereo the left and right sounds are reversed	<ul style="list-style-type: none"> <li>• That left and right wires are connected the same way</li> </ul>
When listening to surround (more than 12 surround both sides) the sound is less powerful	<ul style="list-style-type: none"> <li>• That the link connection between each speaker is properly done</li> <li>• That you didn't connect more than six speakers on the link connector.</li> </ul>
Too much low frequencies	<ul style="list-style-type: none"> <li>• That you have checked the low frequency deep switches adjustments</li> <li>• That the position of your speakers is not too close to the corners</li> </ul>
Not enough low frequencies	<ul style="list-style-type: none"> <li>• .That your connections are not out of phase.</li> <li>• That you have checked the low frequency deep switches adjustments</li> </ul>

## OPTIONAL CURVES

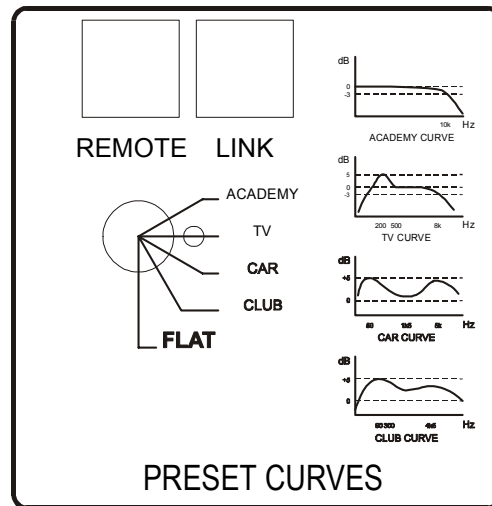
Innovation remains our most important consideration. Thus we have created tuning possibilities with the ability to recreate what the final listener hears.

Integrated into the loudspeakers, these tuning curves reproduce a sound under condition identical to those perceived by the final users.

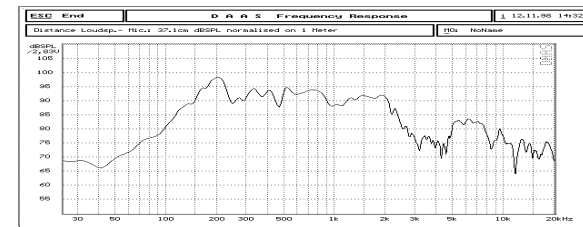
For the sound engineer, this sound is of great utility because it permits him to adapt the recording to its final destination.

## TELEVISION SPEAKER LIMITATION

FAR measured the speakers of more than 20 domestic televisions in the large anechoic room of the university.

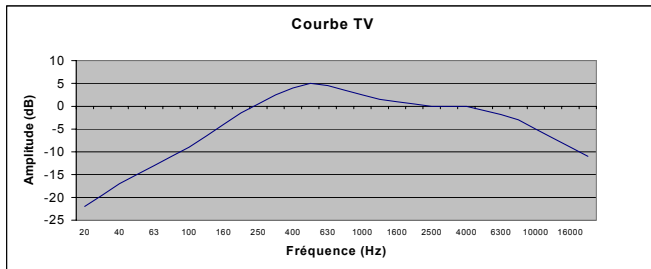


*Figure 5: preset curve*



Results are showing big differences between a studio monitor and these speakers.

The curve we obtained replicates the limitations of the television speaker.

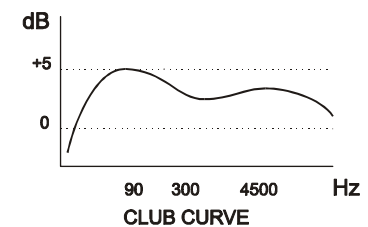
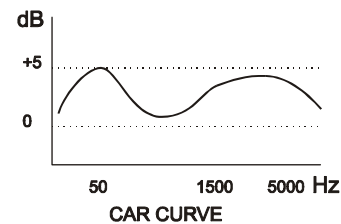


The advantages of this system are :

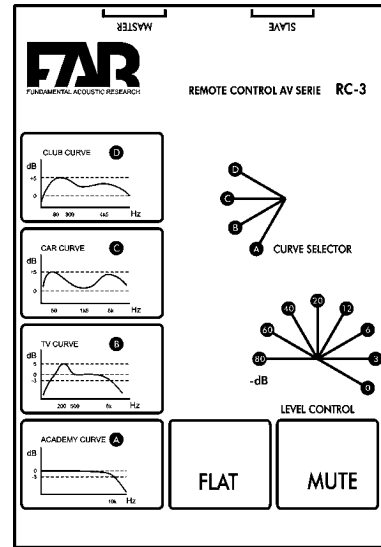
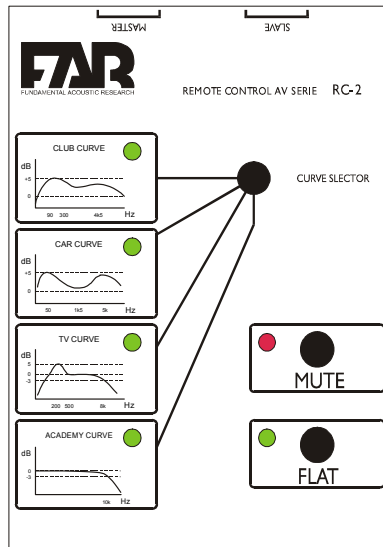
- The ability for the mixer to listen as the end user will do.
- No need to use a small bad speaker in addition (as you generally can see on the consoles )
- The sound colour will obviously be the same as you use the same speaker for both curves.
- The only one position will ensure you to hear the reflections and the own modes the same way

At the moment four curves are available

1. the **TV curve**, to replicate the televisions limitations.
2. the **academy** curve for film mixing,
3. the **CAR** curve that reproduces exactly the frequency response found in car radio speakers
4. the **CLUB** curve that reproduces at their best the sensations you can feel in discotheques.



## REMOTE CONTROL RC-2 / RC-3



### TABLE OF USE

	AV-2	AV-6	AV-20	AV-50	AV-100	Peak 2	Peak-6
RC-2	+	+	+	+	+	0	0
RC-3	+	+	/	/	/	0	0
RC-V	/	/	/	/	/	+	+

+ =ESSENTIAL  
 / =NOT USEFUL  
 0 =NOT AVAILABLE

The optional remote control will let you choose the environment you want to work with .

The four position knob will light the led of the curve you are working with. Each led will light green.

Use the flat switch to work in flat frequency curve. The led will light green

Use the mute switch and the sound will be muted .

You can connect up to any speakers you need , thanks to the slave connector.

So you are able to drive the speakers in stereo mode as well as in 5+1 mode.

the RC-3 upgrades the RC-2 by adding a fine 8 step volume level adjustment.